

# Data Sheet



Article number: 604132056050

Description: Taper bored timing belt pulley  
HTD 56 8M 50 TL 2517

## Measures

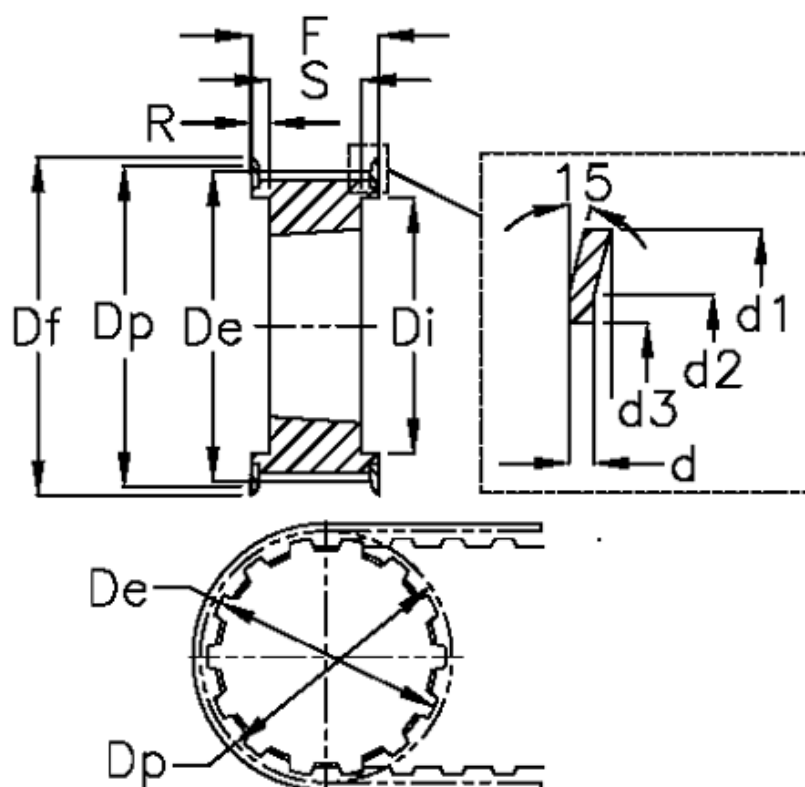

d = 1.5	F = 60	Weight = 3.4
d1 = 150	Flange type = F48	Width = 50
d2 = 145	For bushing = 2517	
d3 = 130	Max bore = 60	
De = 141.23	r = 7.5	
Df = 150	S = 45	
Di = 116	Tooth number = 56	
Dp = 142.6	Type = 8M	